



United Technologies  
turn to the experts

# Carrier Connect™ Wi-Fi Thermostat 33CONNECTSTAT43 Installation Guide





Verify that you have the most current version of this document from [www.hvacpartners.com](http://www.hvacpartners.com) or your local Carrier office.

Important changes are listed in **Document revision history** at the end of this document.

CARRIER CORPORATION ©2019. All rights reserved throughout the world. i-Vu is a registered trademark of Carrier Corporation. All other trademarks are the property of their respective owners.

# Contents

<b>What is the Carrier Connect™ Wi-Fi Thermostat?</b> .....	<b>1</b>
Specifications .....	1
<b>Wiring the Carrier® Connect™ Wi-Fi Thermostat</b> .....	<b>2</b>
To wire the thermostat to equipment.....	2
To wire and mount the thermostat .....	5
To connect a remote input (sensor or contacts) .....	7
<b>Registering and setting up a mobile device for enhanced access</b> .....	<b>9</b>
Using the Connect website or app .....	10
<b>Configuring the system</b> .....	<b>13</b>
To configure advanced SYSTEM SETTINGS.....	14
<b>Operating your system using the Carrier® Connect™ Wi-Fi Thermostat</b> .....	<b>20</b>
Occupancy.....	20
Supply fan .....	21
Cooling.....	21
Econ enable .....	21
Heating.....	22
Dehumidification .....	22
Humidification .....	23
Filter status .....	23
Holidays.....	23
<b>Using the Carrier® Connect™ Wi-Fi Thermostat's screens</b> .....	<b>24</b>
HOME .....	24
SETPOINT .....	25
MODE .....	26
SETTINGS .....	26
HUMIDITY .....	27
FAN.....	29
PROGRAM.....	29
HOLIDAY .....	30
BANNER.....	30
DATE and TIME .....	30
SOFTWARE screen and BACKLIGHT screen .....	31
ADVANCED .....	31
FILTER.....	32
LOCKOUT .....	32
CLEAN .....	33
LOG.....	33
STATUS .....	33
SERVICE.....	34
<b>Installation test</b> .....	<b>35</b>
<b>Troubleshooting</b> .....	<b>36</b>
Outputs based on demand and configuration .....	36
Fault definitions .....	37
Recovering from a power outage .....	38
Resetting wi-fi access .....	38
<b>Document revision history</b> .....	<b>40</b>





## What is the Carrier Connect™ Wi-Fi Thermostat?

The Carrier® Connect™ Wi-Fi Thermostat (Part #33CONNECTSTAT43) is a thermistor-based wireless thermostat that can sense a 10k type-2 OAT or a remote space or return air sensor and can control up to 4 heating and 3 cooling stages.

**The Carrier® Connect™ Wi-Fi Thermostat package includes:**

- Thermostat
- Mounting Hardware - two screws with drywall anchors and one security screw
- Quick Start Guide - Catalog No. 11-808-729-01

**Some of the features:**

- Supporting standard air conditioning and heat pump rooftop and split units
- 7-day scheduling with up to 4 periods per day
- Holiday scheduling
- Full-color touchscreen that's easy to navigate
- Remote programming and monitoring using secure Apple® or Android® mobile app or Web portal
- Text and email service alerts
- Automatic software updates via Wi-Fi

## Specifications

Power requirements	24 Vac +/- 10% @ 3 VA
Network Requirements	Wi-Fi connectivity supports Wi-Fi: 802.11 a/b/g/n standards on 2.4 GHz networks
Environmental operating range	32° to 104°F (0° to 40°C), 10 to 95% relative humidity, non condensing
Mounting	Standard 4x2-in. electrical box using the 6-32 x 1/2" mounting screws provided
Overall dimensions	Width: 5.13 in. (13 cm) Height: 3.23 in. (8.2 cm) Depth: 0.94 in. (2.4 cm)
Listed by	FCC Part 15, Subpart J compliant

# Wiring the Carrier® Connect™ Wi-Fi Thermostat

## To wire the thermostat to equipment

---

### Packaged Rooftop Units

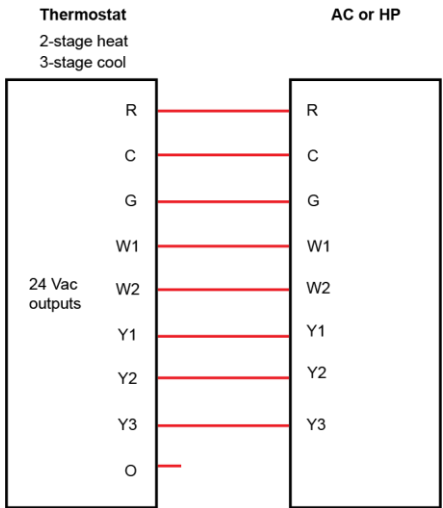

### Hydronic Fan Coil

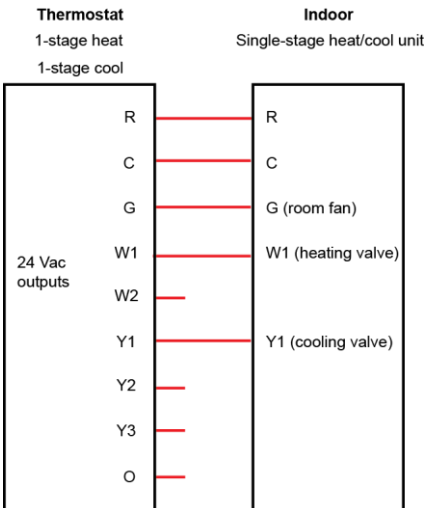

### Dual fuel systems (Furnace & heat pumps)

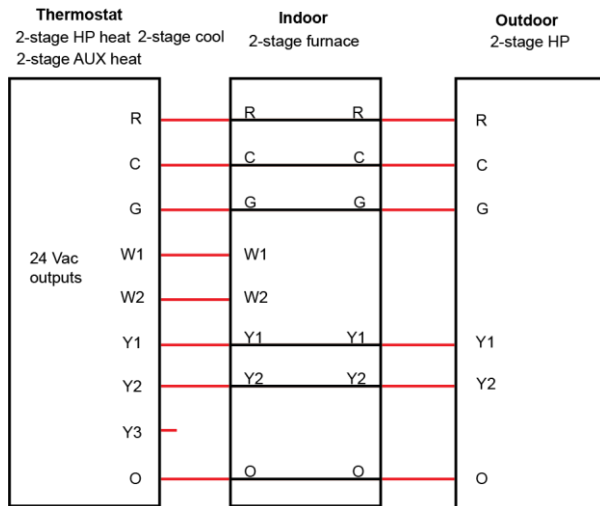

### Furnace/AC System

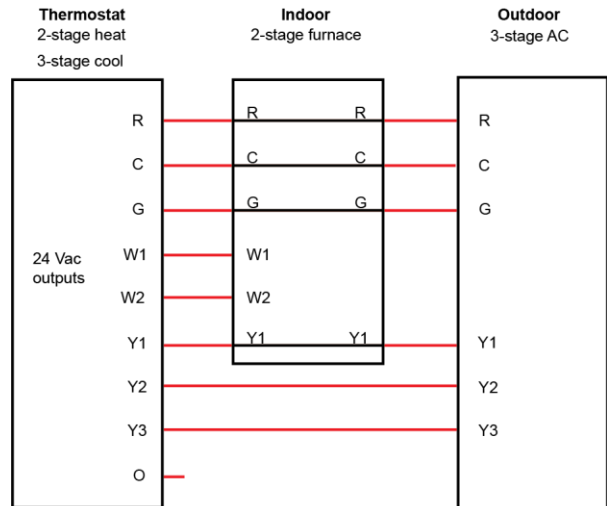

### Water Source Heat Pump

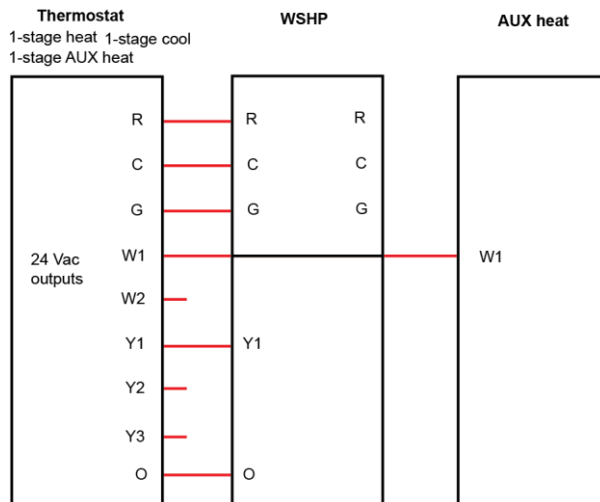

### Air Handler or DX Fan Coil/AC Split System

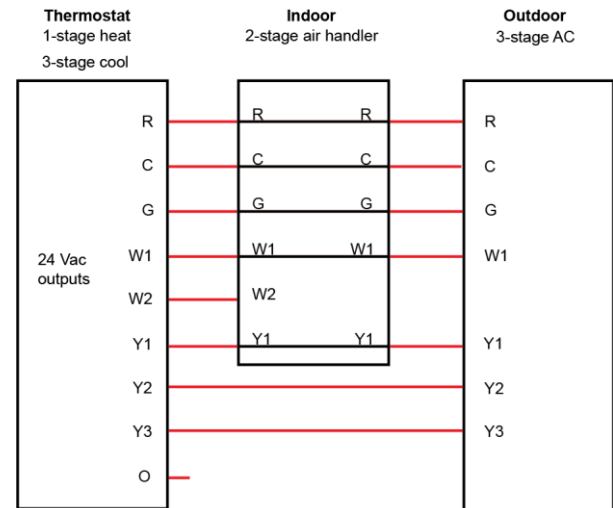

### Air Handler or DX Coil/Heat Pump split system

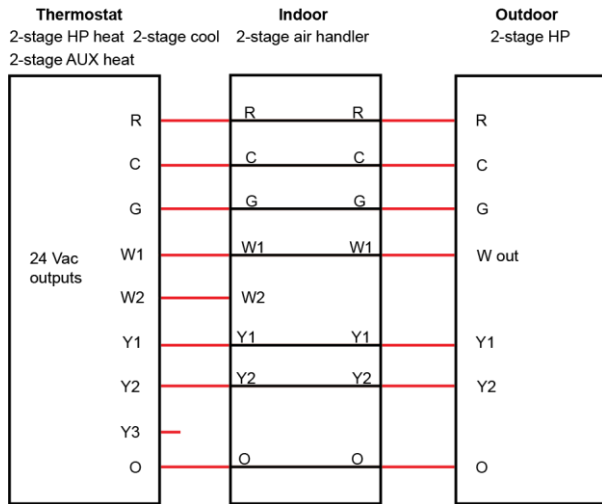



## To wire and mount the thermostat

- 1 Turn off 24 Vac power at the equipment circuit breaker or the system switch.
- 2 Place the thermostat base against your wall to mark drill holes.
- 3 Drill the anchor holes or use existing holes to mount the wallplate.
  - Drywall – Drill 3/16" hole for the anchor.
  - Plaster – Drill 7/32" hole for the anchor.
- 4 Pull wires through opening in base.
- 5 Attach the base to the wall with the provided screws.

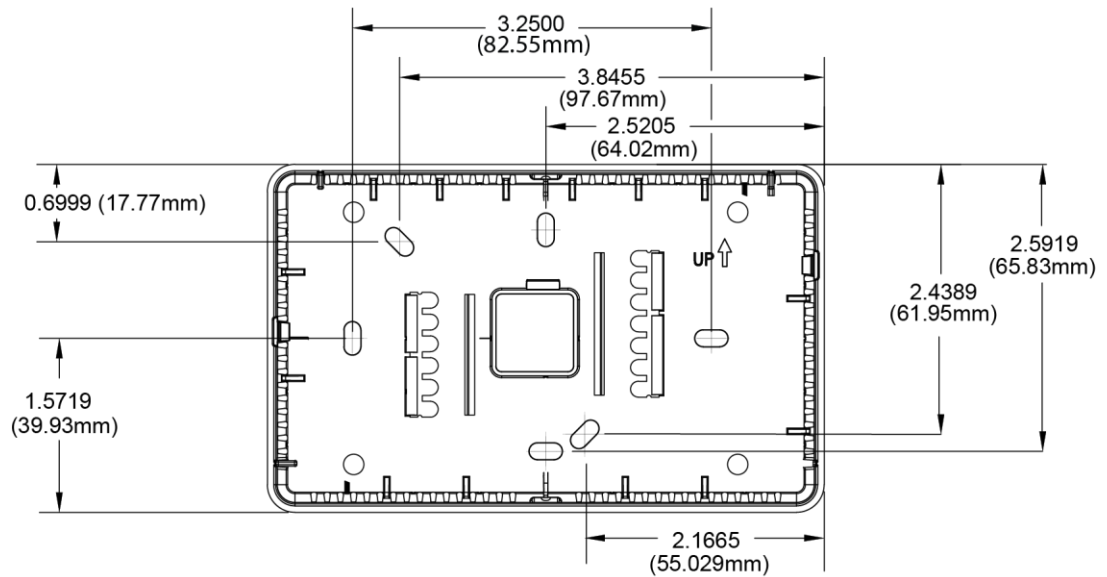

- 6 Straighten the wires and match your wire configuration to the terminals on the base.
- 7 Connect each wire individually by pushing down on the quick connect tab, inserting it into the connector opening, and then releasing the tab.

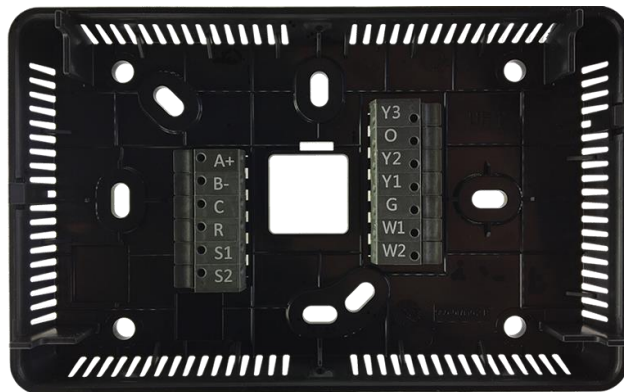

- 8 Attach the thermostat face by aligning it with the hinge guide on top of the back.



- 9 Turn on the 24 Vac power. The thermostat displays the **HOME** screen. See *HOME* (page 24) for details.

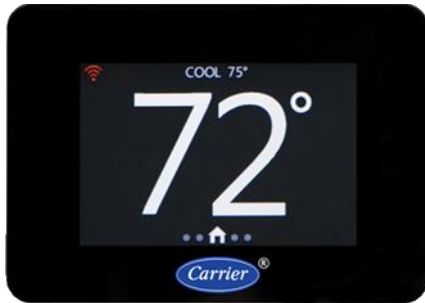

- 10 Configure your system as described in this document.

## To connect a remote input (sensor or contacts)

**NOTE** Use the specified type of wire and cable for maximum signal integrity.

Power	N/A
Description	Stranded, twisted pair
Conductor	If < 100 ft (30.5 meters) 22 AWG, unshielded If > 100 ft (30.5 meters) 22 AWG, shielded
Maximum length	500 feet (152 meters)
Insulation	Plenum rated

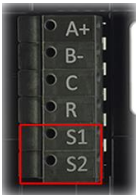

Use Remote Sensor input terminals S1 and S2 for the following inputs:

- OAT
- T55
- Occupancy contacts
- Econ Fault

### Wiring for space temperature sensor averaging

#### 4 sensors

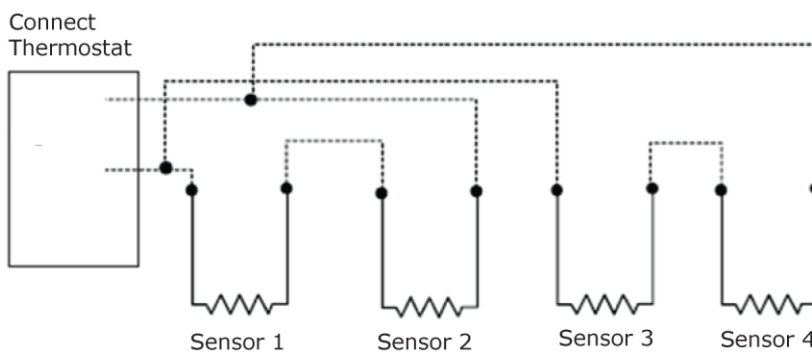

**9 sensors**

Connect  
Thermostat

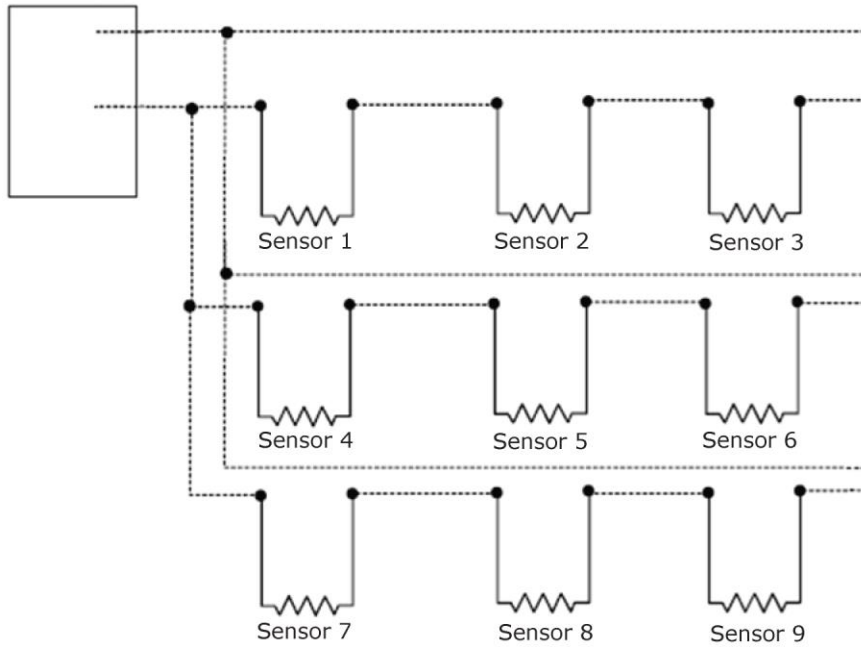

## Registering and setting up a mobile device for enhanced access

Downloading the Connect™ App provides enhanced access to your device. 7-day programming is only available on your mobile device. The Connect™ App is available for Apple iOS® at App Store® or at Google Play® for Android devices. Search for **Carrier Connect™ Thermostat**.

**NOTE** Device compatibility: Apple iOS® 7.0 or later or Android 4.2 or later

- 1 After downloading Connect™ App, select **USER SETUP** and **Register New Account**.

**NOTE** You can also register new accounts using the website connectstat.carrier.com.

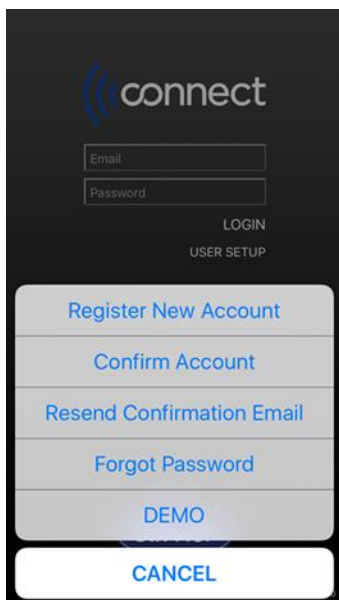

- 2 Enter an email address that you can access on your mobile device and receive the confirmation email to complete the registration process.
- 3 Select **SETUP NEW THERMOSTAT** and follow the Connect™ App instructions.

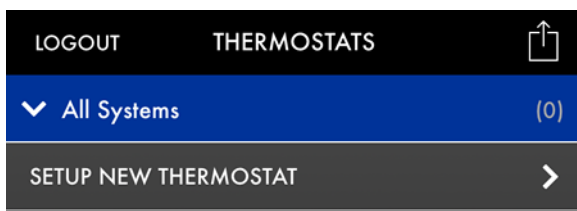

- 4 After registering the thermostat, enter servicing contractor's name and phone number on the **SERVICE INFO** screen.
- 5 On the **THERMOSTATS** screen, select the thermostat from list and the mobile app's **HOME** screen appears.

## Using the Connect website or app



---

After you register for an account, you can access the thermostat by using the app directly or through the Web at [connectstat.carrier.com](http://connectstat.carrier.com).

You can:

- Monitor the thermostat operation
- Set up occupied and unoccupied (holiday) schedules
- Adjust setpoints
- Share thermostat access with other users
- Create groups of thermostats that you have registered
- Create groups of thermostats that other owners have shared with you
- Get online product information
- Find local dealer support

### To navigate

- On a touchscreen device, use any of the following:
    - swipe the screen
    - tap the arrow on the side
    - tap a dot on the bottom of the screen on either side of the HOME button
  - On a non-touchscreen device, click on the gray arrow  on either the side of the screen.
  - You can press or click  to access the following drop-down menu:
    - **My Systems**
    - **My Account**
    - **Shared Systems**
    - **Product Information**
    - **Find and Expert**
    - **Logout**
- 1 After logging in, a list appears of thermostats that you have registered and that have been shared with you.
  - 2 Click the **CONFIGURE** button .

- 3 Swipe or click to navigate to the **SETTINGS** screen.

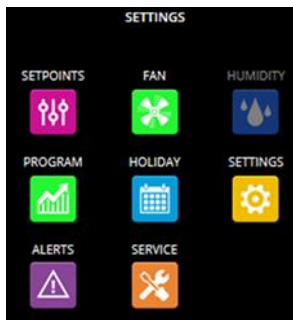

**NOTES**

- o Navigate by clicking or pressing the buttons such as **SETPOINTS, FAN, PROGRAM**, etc..
- o Grayed out function buttons indicate that feature is not being used on the thermostat.

Screens	Use to...
<b>SETPOINTS</b>	Adjust the occupied and unoccupied setpoints by selecting each temperature.
<b>FAN</b>	View and modify fan settings. <ul style="list-style-type: none"> <li>• The default setting for fan operation is <b>AUTO</b> for both Occupied and Unoccupied periods. When operating in <b>AUTO MODE</b>, the fan only runs when there is an active heating or cooling demand.</li> <li>• When you select <b>ON</b>, the fan runs continuously, except during the <b>Blower On Delay</b> when a heat cycle is starting. There is a 30-second minimum on/off timer when changing the <b>FAN MODE</b>.</li> </ul>
<b>NOTE</b> The following selections are not available if the thermostat has been configured for non-programmable operation.	
<b>HUMIDITY</b>	Adjust the thermostat's humidify and dehumidify setpoints.
<b>PROGRAM</b>	You can: <ul style="list-style-type: none"> <li>• Set Occupied and Unoccupied start times, depending on the configured number of periods and the user's security level.</li> <li>• Select the time at the bottom of the screen to adjust the start or stop time of each period in 15 minute increments.</li> <li>• Select <b>Copy</b> to apply that schedule to other days of the week.</li> <li>• Adjust the setpoints for each period.</li> </ul>

<b>Screens</b>	<b>Use to...</b>
<b>HOLIDAY</b>	<p>Set <b>HOLIDAY</b> (same as Unoccupied) periods with the following options:</p> <ul style="list-style-type: none"><li>• Length of time from 1 to 365 days</li><li>• Same day of each week of the month</li><li>• Specific day of specific week(s) of the month</li></ul> <p><b>NOTE</b> Requires advanced security level to edit these settings</p> <ul style="list-style-type: none"><li>• Select <b>+ADD HOLIDAY</b> to the add start month, day, and number of days.</li><li>• Select <b>ADVANCED</b> to configure same day of each week(s) of that month.</li><li>• To delete a holiday on the:<ul style="list-style-type: none"><li>○ Mobile app - swipe the selected holiday to the left and select <b>Delete</b></li><li>○ Web app - select <b>x</b> on right side of the holiday</li></ul></li></ul>
<b>SETTINGS</b>	<p>Enter the name and location of the thermostat for the user's reference. The user can enter an email address for alerts and a mobile phone number to receive text alert messages.</p> <p><b>NOTE</b> Requires advanced security level to edit these settings.</p>
<b>ALERTS</b>	<p>Displays a list of alerts that have been flagged in the thermostat.</p>
<b>SERVICE</b>	<p>Displays the name and phone number of the service company or individual who is responsible for servicing the system.</p> <p><b>NOTE</b> Requires advanced security level to edit these settings.</p>



## Configuring the system

- 1 On the thermostat, not a mobile device, swipe the **HOME** screen twice to the left to navigate to the **MODE** screen and ensure the **MODE** is **OFF**.

**NOTE** The yellow line above a button indicates it is the current **MODE**.



- 2 Swipe to go to the **FAN** screen and then press and hold the **Fan Button**  for 5 seconds to get to the **SYSTEM SETTINGS** screen.

**NOTE** You can **ONLY** access the **SYSTEM SETTINGS** screens from the thermostat itself, not the app or web.

- 3 Enter the 3-digit security PIN code, if applicable, to open the **SYSTEM SETTINGS** screen.



- 4 Use the advanced options on the **SYSTEM SETTINGS** screens to configure and setup your system, change, and view options.

### NOTES

- The yellow **Row Indicator** at the right side of the screen indicates the current location in the list of advanced settings options. Swipe up or down to navigate through options and then tap to select one.
- Swipe on any of the **SYSTEM SETTINGS** sub-screens to return to the **SYSTEM SETTINGS** main screen.

## To configure advanced SYSTEM SETTINGS

You can only adjust the following the **SYSTEM SETTINGS** screens and parameters on the thermostat itself. You cannot access them on a mobile device.

You can select **FACTORY DEFAULTS** to restore all default settings to the original values.

Parameter Name/Description	Default and Range
<b>HEAT EQUIP TYPE</b> — The equipment heating type. If you select <b>GAS HEAT</b> and the <b>COMPRESSOR TYPE</b> for <b>HP</b> , then the defined <b>DUAL FUEL</b> thermostat operation is used for heating.	D: GAS HEAT R: GAS HEAT/ELECTRIC
<b>HEATING EQUIP STAGES</b> — The number of gas heating stages or E- heating stages in the equipment. <b>NOTE</b> If set to 2, the W2 relay output is not available for optional functions, such as Humidifier, Dehumidifier, or Occupancy output.	D: 1 R: 1 to 2
<b>COMPRESSOR TYPE</b> — The type of the unit's compressors(s). <b>NOTE</b> Select <b>HP</b> for the <b>HEAT EQUIP TYPE</b> to define the auxiliary heat type.	D: A/C R: NONE, A/C, HP
<b>COMPRESSOR STAGES</b> — The numbers of compressors. <b>NOTES</b> <ul style="list-style-type: none"> <li>• If <b>COMPRESSOR TYPE</b> is set to <b>HP</b>, the number of stages also defines the number of HP heating stages.</li> <li>• If set to <b>3</b>, the Y3 relay output is used for the third-stage compressor and the thermostat configuration may be limited for the following: <ul style="list-style-type: none"> <li>○ Humidifier</li> <li>○ Humid-MiZer™ dehumidification</li> <li>○ Occupancy Output</li> </ul> </li> </ul>	D: 2 R: NONE, 1 to 3
<b>AUTO ALLOWED</b> — Enables and disables the thermostat to automatically switch from heating to cooling to maintain the temperature between the setpoints.	D: YES R: YES/NO
<b>PROG OR NON-PROG</b> — Allows the thermostat to operate as a non-programmable (simplified) thermostat or a programmable thermostat with 2 or 4 time periods per day.	D: PROG R: PROG / NON-PROG
<b>MAX HOLD TIME</b> — The thermostat setpoints cannot be overridden by the user. When the <b>SCHEDULE PAUSED</b> button is pressed on the <b>SETPOINTS</b> screen ( <b>SCHEDULE IS RUNNING</b> ), and the user changes the setpoint, the <b>MAXIMUM TEMPORARY HOLD TIMER</b> is started with the value selected here and displayed in the clock location.	D: 2 hours R: OFF 1-6 hours
<b>FAHRENHEIT OR CELSIUS</b> — The temperature scale.	D: °F R: °F/°C

Parameter Name/Description	Default and Range
<p><b>SMART RECOVERY</b> — Transitions the conditioned space from one programmable temperature period to the next with 1°F increments of the heating setpoint or with 1°F decrements of the cooling setpoint, so that by the time the next period starts, the setpoints are at the desired temperature. The purpose of the gradual transition is to use less energy by preventing staging up (because of a higher demand) to higher stages. The transitions occur in a linear fashion over the smart recovery time period.</p> <ul style="list-style-type: none"> <li>• If you start a temporary hold in the middle of a smart recovery, the setpoints of the temporary hold are used.</li> <li>• If a temporary hold is already active during the time that smart recovery would have been started, a smart recovery does not start.</li> <li>• If the temporary hold ends in the middle of what would have been a smart recovery, the smart recovery starts where it would have been in the linear progression at the same time as when the temporary hold was not active.</li> </ul>	<p>D: 30</p> <p>R: NO, 30, 60, 90 minutes</p>
<p><b>FAN ON WITH W</b> — Supplies a fan output demand as soon as a W1 or W2 output demand is active.</p>	<p>D: YES</p> <p>R: YES/NO</p>
<p><b>REVERSING VALVE</b> — Defines whether the <b>ON</b> state of the reversing valve is used for heating or cooling when <b>COMPRESSOR TYPE</b> is set to <b>HP</b>.</p> <ul style="list-style-type: none"> <li>• When the <b>ON</b> state of the reversing valve is used for cooling, the signal is typically referred to as a <b>O</b>.</li> <li>• When the <b>ON</b> state of the reversing valve is used for heating, the signal is typically referred to as a <b>B</b> demand.</li> <li>• If <b>COMPRESSOR TYPE</b> is set to <b>HP</b>, the thermostat configuration may be limited for the following: <ul style="list-style-type: none"> <li>• Humid-MiZer™ dehumidification</li> <li>• Humidifier operation</li> <li>• Occupancy Output</li> </ul> </li> </ul>	<p>D: COOL</p> <p>R: COOL/HEAT</p>
<p><b>SPACE TEMP OFFSET</b> — Calibrates the internal space temperature sensor.</p>	<p>D: 0°F</p> <p>R: -5°F to 5°F</p>
<p><b>SPACE HUM OFFSET</b> — Calibrates the internal relative humidity sensor.</p>	<p>D: 0%</p> <p>R: -9% to 9%</p>
<p><b>AUTO CHANGEOVER</b> — The minimum time between switching from heat-to-cool or from cool-to-heat demands when in <b>AUTO MODE</b>. The timer begins when the <b>MINIMUM OFF TIMER</b> expires.</p>	<p>D: 30 MIN</p> <p>R: 5, 10, 15, 20, 25, 30 MIN</p>

Parameter Name/Description	Default and Range
<p><b>REMOTE SENSOR</b> – Determines whether the remote sensor hardware input is:</p> <ul style="list-style-type: none"> <li>• <b>NONE</b> – Not used</li> <li>• <b>NONE</b> or <b>SPACE</b> – The outdoor temperature is acquired by Wi-Fi through the server, based on the location of the mobile device used to connect the thermostat to a router, or based on the ISP location, if a computer connects the thermostat to a router.</li> <li>• <b>OUTDOOR</b> – Senses the outdoor temperature  <b>NOTE</b> The outdoor temperature is not available if the thermostat is not connected to Wi-Fi or if you do not select <b>OUTDOOR</b>.</li> <li>• <b>AVERAGE</b> – Space temperature results from averaging the internal the external sensor</li> <li>• <b>OCCUPANCY</b> – An external source is accessed to determine if the setpoints are Occupied or Unoccupied. When Normally Open contacts close, the Occupied setpoints are used.  <b>NOTE</b> When selected, the <b>NON-PROG</b> setting is automatically set and is not displayed in the Installer Settings until this parameter is changed.</li> <li>• <b>FAULT INPUT</b>– An external source is used to detect a fault, as determined by the attached Economizer.</li> </ul>	<p>D: NONE</p> <p>R: NONE SPACE OUTDOOR AVERAGE OCCUPANCY FAULT INPUT</p>
<p><b>COOL LOCKOUT</b> – Delays the cooling equipment demands if the outdoor air temperature is below the selected value. There is a <b>SYSTEM EVENT</b> warning if the mode and space temperature dictate that there should be a cooling demand and the outdoor temperature is preventing this demand.</p>	<p>D: 55°F</p> <p>R: OFF 0°F to 80°F in 5°F increments</p>
<p><b>LOW COOL LOCKOUT</b> – (Heat pump operation only) Enables the thermostat to start all cooling stages on a demand for cooling based on the configured value. Normal cooling always starts with first stage compressor (Y1) and stages up to the second (Y2), when the demand is sufficient and staging and cycle timer constraints are satisfied.</p> <p>If the outdoor temperature is equal to or greater than the configured value of 80°F to 110°F, all stages of cooling are energized. If set to <b>ON</b>, all stages are energized on a call for cooling. The outdoor temperature must also be greater than the <b>COOL LOCKOUT</b> value. When a cooling cycle starts under a high cool latch, it finishes the cooling cycle on <b>HIGH STAGE</b>. If the cooling equipment is energized to satisfy a dehumidify demand only (no cooling demand), the latch is not applied.</p>	<p>D: OFF</p> <p>R: OFF 80°F to 110°F in 5°F increments ON</p>
<p><b>LOW HEAT LOCKOUT</b> – (Heat Pump operation only) Enables the thermostat to start all compressor heating stages on a demand for heating, based the configured value. When the <b>COMPRESSOR TYPE</b> is set to <b>HP</b> and compressor heat is requested, it always starts with the first compressor stage (Y1) and stages up to second stage (Y1 and Y2) when the demand is sufficient and staging and cycle timer constraints have been satisfied.</p> <p>If the outdoor temperature is equal to or less than the configured value of 20°F to 50°F, both the first and second stages of the compressor are energized to satisfy all heat pump heating demands. If set to <b>ON</b>, both compressors are energized on a call for heating. The outdoor temperature must also be greater than the <b>HP LOCKOUT</b> value. When a cycle starts under a high heat latch, it finishes the heating cycle on <b>HIGH STAGE</b>.</p>	<p>D: OFF</p> <p>R: 20°F to 50°F in 5°F increments ON</p>
<p><b>TIME BETWEEN FUEL TYPES</b> – The minimum time limit between switching from one fuel type to another (other staging rules may also be in effect). It is only used if the <b>COMPRESSOR TYPE</b> is set for <b>HP</b>.</p>	<p>D: 15 minutes</p> <p>R: 10, 15, 20, 25 minutes.</p>

Parameter Name/Description	Default and Range
<b>CYCLE TIMER</b> — The maximum number of heat cycles per hour.	D: 4 R: 2, 4, 6, 8
<b>HUMIDIFIER</b> — The output relay enables a field-installed humidifier. The humidifier is on if there is humidity demand and any heating equipment is on. If set to <b>YES</b> , the thermostat cannot be configured for Humidi-MiZer™ or Dehumidification. See <b>HUM/DEHUM OUTPUT</b> in this table for output relay details.	D: NO R: YES/NO
<b>DEHUMIDIFIER</b> — Sets the output relay to enable a factory-installed Humidi-MiZer™ for dehumidification or to use the first stage of cooling. <ul style="list-style-type: none"> <li>If HUMDIMIZER, the output relay energizes the Humidi-MiZer™ on the Carrier unit.</li> <li>If YES, the Y1 relay is energized. A new space temp setpoint is calculated to force cooling operation.</li> </ul> <p><b>NOTE</b> For details about this calculation, see HUMIDITY.</p> <ul style="list-style-type: none"> <li>If OVRCL(2), it uses the first stage of cooling to satisfy a dehumidification demand, but will not overcool the space by more than 2 °F.</li> <li>If dehumidification is configured, the thermostat cannot also be configured for a humidifier. Additional optional functions may be limited, based on the flex outputs available.</li> </ul>	D: NO R: NO YES OVRCL(2) HUMDIMIZER
<b>MAX HEAT SETPOINT</b> — The maximum heating setpoint available on the Heat Setpoint Wheel and the maximum heating setpoint that can be used during the occupied program schedule.	D: 88 °F R: 50 °F to 88 °F
<b>MIN COOL SETPOINT</b> — The minimum cooling setpoint that is available on the Cool Setpoint Wheel and the minimum cooling setpoint that can be used during the occupied program schedule.	D: 52 °F R: 52 °F to 90 °F
<b>AUX HEAT LOCKOUT</b> — The outdoor temperature value that lockouts the auxiliary heat. If the <b>AUX HEAT LOCKOUT</b> temperature setting is not <b>OFF</b> , and the outdoor air temperature is greater than <b>AUX HEAT LOCKOUT</b> value, then the <b>Aux Heat</b> (W1 and W2) outputs are not energized. Once the output is energized, it remains energized until the demand algorithm no longer requires the capacity of the auxiliary heat, regardless of the value of the outdoor air temperature. <p><b>NOTE</b> If the <b>MODE</b> is emergency heat (<b>E-HEAT</b>), the auxiliary heat is allowed to be energized regardless of the outdoor temperature.</p>	D: OFF R: OFF 5 °F to 55 °F in 5 °F increments
<b>HP LOCKOUT</b> — If you select <b>OFF</b> , the heating equipment cycle always starts with the heat pump, regardless of the outdoor air temperature. <ul style="list-style-type: none"> <li>If you select a lockout temperature and the outdoor air temperature is less than the selected temperature, the heating cycle is started with the <b>AUX HEAT</b> source.</li> <li>If the outdoor air temperature is equal to or greater than the selected temperature, the heating cycle is started with the heat pump.</li> <li>If the outdoor temperature is not available, all heating cycles start with compressor heat. Once the heat pump is energized, it remains energized until the heating demand no longer requires heat pump heating, regardless of the outdoor air temperature.</li> <li>When the heat pump is not energized, but there is sufficient demand to request heat pump heating, the heat pump lockout temperature is checked against the outdoor air temperature, and if the outdoor air temperature is greater than the heat pump lockout temperature, the heat pump is energized.</li> </ul>	D: OFF R: OFF 5 °F to 55 °F in 5 °F increments

Parameter Name/Description	Default and Range
<p><b>STAGE DELAY</b> – The minimum amount of time the current stage must be energized before staging up to the next stage of capacity.</p> <p><b>NOTE</b> If the system demand is greater than 3°F, then this configuration is ignored for the current heating or cooling cycle because the staging timers are canceled, to allow full equipment capacity to meet the large demand.</p>	<p>D: 10 MIN</p> <p>R: 2 MIN to 15 MIN</p>
<p><b>FORCED STAGE UP</b> – The amount of time another stage of heat or cool is enabled if the space temperature conditions are not improving. If the time in a current demanded stage reaches the selected forced stage-up time, the thermostat stages up to the next available stage of capacity, even if <b>DIFFERENTIAL</b> demand is not met.</p>	<p>D: 30 MIN</p> <p>R: OFF 10 MIN to 120 MIN in 10 minute increments</p>
<p><b>DIFFERENTIAL</b> – The required difference between the current space temperature and the setpoint, before demand is initiated. This value is additive for each new stage of equipment being demanded.</p> <p><b>EXAMPLE</b> A chosen <b>DIFFERENTIAL</b> value of 0.5°F requires 0.5°F difference between setpoint and space temperature before first stage is turned on. Then, 1°F of difference between setpoint and space temperature is necessary before the second stage is turned on.</p>	<p>D: 1.0°F</p> <p>R: 0.3°F to 2.0°F in 0.1°F increments</p>
<p><b>AIR FILTER REMINDER</b> – The number of hours before a <b>SYSTEM EVENT</b> reminds the occupant to change the indoor air filter.</p> <ul style="list-style-type: none"> <li>• If set to <b>OFF</b>, a <b>SYSTEM EVENT</b> will not occur to remind the homeowner to change the indoor air filter.</li> <li>• Decrements to the timer happen each hour of total equipment runtime.</li> <li>• Minutes are not stored in non-volatile memory, so a power reset clears out the minutes within each hour of run time.</li> <li>• Once the number of hours is initially set or later changed, the filter timer must be reset on the <b>SETTINGS</b> screen.</li> </ul>	<p>D: 3000 HRS</p> <p>R: OFF 500 HRS to 15000 HRS in 500 hour increments</p>
<p><b>OCCUPANCY OUTPUT</b> – When set to <b>ON-Y3</b>, <b>ON-O/B</b>, or <b>ON-W2</b>, selected relay output equals current Occupancy state. Can be used for ECON Enable.</p> <p><b>NOTE</b> The <b>OCCUPANCY OUTPUT</b> option is not displayed or available if <b>Y3</b>, <b>O</b>, and <b>W2</b> relays are being used; i.e. Humidification/ Heat Pump/ 3-stage cooling/ etc..</p>	<p>D: OFF</p> <p>R: OFF ON-Y3 ON-W2 ON-O/B</p>
<p><b>OCCUPANCY INPUT</b> – This setting changes the current heating and cooling setpoints to the option selected for <b>MAX HOLD TIME</b>. This occurs when the short is detected on the Remote Space Sensor for the duration of 2 to 5 seconds.</p>	<p>D: Occupied</p> <p>R: Occupied Unoccupied</p>
<p><b>LINE FREQUENCY</b> – Used to increment operational timers within the thermostat to ensure timing accuracy.</p>	<p>D: 60HZ</p> <p>R: 50HZ 60HZ</p>
<p><b>DISCONNECT WIFI</b> – Disconnects the thermostat from the Wi-Fi network.</p> <p> <b>CAUTION</b> Disconnecting the Wi-Fi requires setting up the Connect Thermostat using the Connect mobile application in order to re-establish Wi-Fi connectivity.</p>	

Parameter Name/Description	Default and Range
<p><b>HUM/ DEHUM OUTPUT</b> – Select the output channel for Humidify or Dehumidify (Humidi-MiZer™) functions.</p> <p><b>NOTE</b> Selections could be limited by configurations such as, 3-stage cooling, 2-stage heat, Heat Pump, and Occupancy output.</p>	<p>D: OFF</p> <p>R: OFF ON-Y3 ON-W2 ON-O/B</p>
<p><b>INSTALLATION TEST</b> – See the <b>Installation Test</b> (page 35) section for detailed instructions.</p>	
<p><b>RESTORE DEFAULTS</b> – Press and hold the <b>5</b> button for 5 seconds to initiate and restore all system setting defaults. Press the <b>CANCEL</b> button to go back to <b>SYSTEM SETTINGS</b> screen.</p>	

## Operating your system using the Carrier® Connect™ Wi-Fi Thermostat

The thermostat supports the following types of constant volume units:

- Standard heat/cool unit types with up to 3 stages of mechanical cooling, up to 2 stages of gas or electric heating, and up to 4 stages for non-Carrier heat pumps
- Heat pump units utilizing a reversing valve output for heating and cooling control
- Carrier heat pump unit with an OEM defrost control board

### NOTES

- Humidification or dehumidification control strategies are available for appropriately equipped units.
- The following configurations have interdependencies that may preclude the use of others:
  - Reversing valve
  - Third-stage cooling
  - Humidification
  - Dehumidification
  - Occupancy Output
  - The flex outputs, Y3, O, and W2, may be available for optional functions.

**EXAMPLE** In a single stage heating system, the W2 output could be used as the Occupancy output to enable the ECON during occupied periods.

## Occupancy

---

Configure the thermostat to operate in a programmable or non-programmable mode. Non-programmable operates continuously in occupied mode. Programmable operates as a 7-day programmable thermostat for either 2 or 4 periods per day. You can set each period as occupied or unoccupied.

If you configure **Smart Recovery** for 30 to 90 minutes, the occupied start time increases up to the maximum time, in order to bring the space to the occupied setpoints at actual occupied time.



## Supply fan

---

Configure the supply fan for **ON** or **AUTO**, in either occupied or unoccupied mode.

- **ON** – Fan runs continuously regardless of demand
- **AUTO** – Fan cycles heat or cool demand if there is a demand for humidity or dehumidification

## Cooling

---

The thermostat's application and configuration determine the specific cooling sequence. It can control up to 2 stages of cooling, with an additional output for a reversing valve, for non-Carrier heat pump applications, or up to 3 stages of cooling for non-heat pump applications.

**NOTE** The cooling stages are controlled based on a drift algorithm and the configurable **DIFFERENTIAL** value (.5° F default).

The following conditions must be true for the cooling to operate:

- The OAT must be above the **COOL LOCKOUT** (55° F default), if enabled
- The cooling stage 5-minute minimum off-timer has expired
- The space temperature has exceeded the cooling setpoint by the **DIFFERENTIAL** value (.5° F default)

Additional stages are added and dropped, based on demand using the **DIFFERENTIAL** value, **STAGE DELAY** timer, and **FORCED STAGE UP** timer configuration values. If the **LOW COOL LOCKOUT** is configured for **ON**, or between 80° F and 110° F, and the OAT is equal to or greater than that value, cool stages 1 and 2 are energized on a demand for cooling and remain on until the cooling demand is satisfied.

**NOTE** Once a cooling stage is energized, it remains on for a minimum of 5 minutes, regardless of demand.

## Econ enable

---

The thermostat's application and configuration determine the specific economizer enable sequence. You can enable an output relay in **OCCUPANCY OUTPUT**. The output is ON whenever the thermostat is Occupied and OFF when Unoccupied.

**NOTE** The relay options may be limited by other programming options such as Humidity control, Heat Pump, etc..

The status of the economizer may be monitored using a dry contact (N.O.) on the **Remote Sensor Input**.

## Heating

---

The thermostat's application and configuration determine the specific heating sequence. It can control up to 4 stages of heating when configured for non-Carrier heat pump applications, or up to 2 stages of heating for non-heat pump applications. When applied to a Carrier commercial heat pump, **HEAT TYPE** must be set to **GAS**. **HEAT TYPE** set to **ELECTRIC** supports the Carrier 3-stage heat operation using 2 outputs. See Outputs based on demand and configuration.

**NOTE** The heating stages are controlled based on a drift algorithm and the configurable **DIFFERENTIAL** value (.5 °F default).

The following conditions must true for heating to operate:

- The OAT must be below the **HEAT LOCKOUT** (55 °F default), if enabled
- The heating stage 5-minute minimum off-timer has expired
- The space temperature has exceeded the heating setpoint by the **DIFFERENTIAL** value (.5 °F default)

Additional stages are added and dropped, based on demand, using the **DIFFERENTIAL** value, **STAGE DELAY** timer, and **FORCED STAGE UP** timer configuration values. If the **LOW HEAT LOCKOUT** is configured for **ON**, or between 20 °F and 5 °F, and the OAT is equal to or less than that value, heat stages 1 and 2 are energized on a demand for heating and remain on until the heating demand is satisfied.

**NOTE** Once a heating stage is energized it will remain on for a minimum of 5 minutes regardless of demand.

## Dehumidification

---

There is occupied and unoccupied dehumidification on units that are equipped with the Carrier Humidi-MiZer™ from the factory, or by energizing the first stage of cooling and over-cooling by 2 °F.

The following conditions must be true for dehumidification to operate:

- For the Humidi-MiZer™ option, **DEHUMIDIFY** must be set to **HUMIDIMIZER**
- For over-cooling, **DEHUMIDIFY** must be set to **OVRCL 2 °F**
- For non-Humidi-MiZer™ units, **DEHUMIDIFY** must be set to **YES** and must not have an active call for heating or cooling
- Must not be configured for **HUMIDIFY = 3**
- Humidity must be 2% greater than the dehumidify setpoint

Dehumidification ends when **DEHUMIDIFY** is set to:

- **HUMIDIMIZER** and humidity drops 3% below the dehumidify setpoint
- **OVRCL2 °** and space temperature drops below the cooling setpoint by more than 2 °F
- **YES** and space temperature drops below the calculated setpoint or there is a demand for heat or cool.

**NOTE** For details about this calculation, see HUMIDITY.

## Humidification

---

There is occupied and unoccupied humidification on units that are equipped with humidifiers.

The following conditions must be true for humidification to operate:

- **HUMIDIFIER** must be set to **YES**
- Must not be configured for **DEHUMIDIFY**
- Must be in heating mode
- Humidity must be 3% less than the humidify setpoint

Humidification ends when the humidity rises 3% above the humidify setpoint or the heating demand is satisfied.

## Filter status

---

**FILTER STATUS** is based on a supply fan runtime, which you can configure from 500 to 3000 hours. A filter status alert  displays when the filter timer exceeds the configured number of hours. Press to see message.

## Holidays

---

There is a maximum of 24 holiday periods. You can program each holiday period based on a start and stop month date, or day of the month and week, with duration up to 365 days. The holiday schedule uses the first unoccupied period setpoints for temperature control.

## Using the Carrier® Connect™ Wi-Fi Thermostat's screens



### HOME

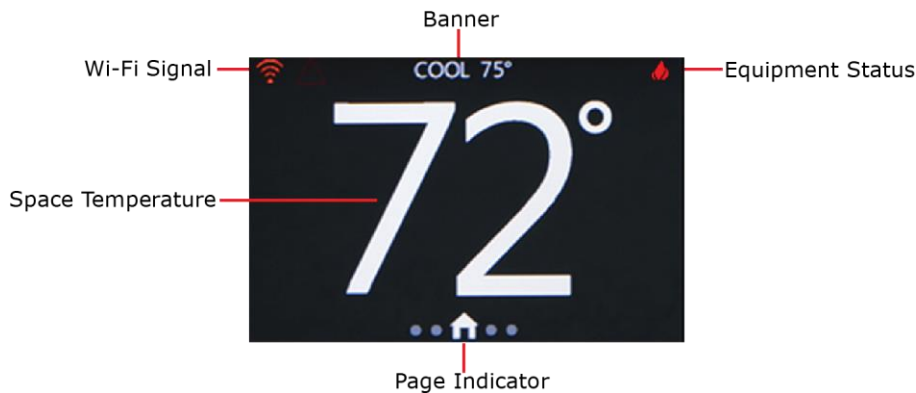

---

The **HOME** screen is typically what the end user sees.



#### Screen functions

- **Banner**
  - Press the center of the scrolling Banner to switch to the screen indicated by the displayed text. You can swipe the banner to change options, or, every 3 seconds, a different screen name scrolls across the top that you can navigate to.  
**NOTE** On the thermostat itself, you can select those screens on the **SYSTEM SETTINGS > BANNER** screen.
- **Page Indicator** — You can tap the **HOME**  icon at any time to go to the **HOME** screen. You can either swipe or tap the dots to the left or right to navigate. The dot turns from gray to white to indicate the page you are on.
- **Wi-Fi Signal**
  -  The more green bars, the stronger the signal
  -  Red indicates it is not currently connected to a router
  - Pressing the **Wi-Fi Signal** displays a screen with connectivity details
- **Space Temperature** — The center portion of the screen displays the sensed space temperature, in whole numbers only. Fahrenheit is the default scale but you can change to Celsius in **SYSTEM SETTINGS**. See *To configure advanced System Settings* (page 13).

- **Equipment Status** — This button is static except when equipment is being activated and then it pulses on and off.
  - If you tap the **Fan mode/operation**  icons, the screen switches to the **FAN** screen.
  - If you tap the **Heat**  or **Cool**  icons, the screen switches to the **MODE** screen.

## SETPOINT

---

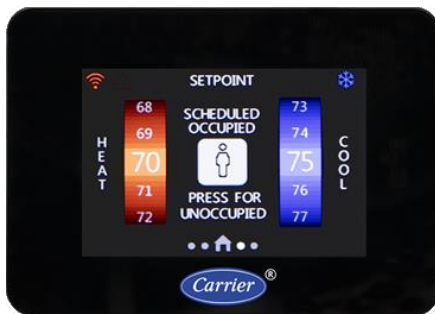

Use this screen to view, adjust, or hold heat and cool setpoints. Use the wheels to adjust setpoints. Drag a wheel up or down or tap the top or bottom of the wheel to increase or decrease by 1 increment.

There are 2 different buttons that can appear in the center of this screen. Press to switch buttons and functions.

- **OCCUPIED/UNOCCUPIED** button
- **PLAY** button allows you to either play (use as is) or alter the program schedule
- Text on top of the button is the current state
- Text beneath the button is what will happen when you press the button

If the schedule is running, the Occupancy button and the text display whether the schedule is currently running **OCCUPIED** or **UNOCCUPIED** setpoints. Press the button to switch heat and/or cool setpoints between Occupied and Unoccupied settings and then the Occupancy button changes to the **PLAY** button.

When the schedule is not running, the text above the Play button says **OCCUPIED** if the heat and cool setpoints are the same as the **OCCUPIED** setpoints or **UNOCCUPIED** if the heat and cool setpoints match the Unoccupied setpoints. If neither is true, **HOLD** displays. When the schedule is paused, the remaining hold time shows in the lower right corner.

## MODE

---

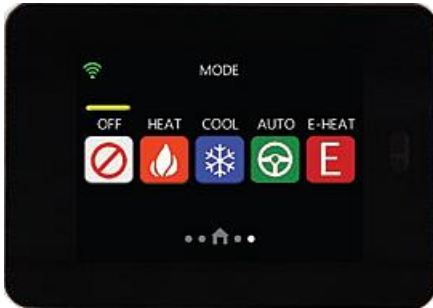

Use this screen to view and change the current **MODE**, including:

- **OFF**
- **HEAT**
- **COOL**
- **AUTO**
- **E-HEAT**

**NOTE** The horizontal yellow bar always appears above the current mode.

The thermostat does not change until the newly selected **MODE** has been on for at least 10 seconds.

### EXAMPLE

When changing the **MODE** from **HEAT** to **COOL**, the thermostat must first satisfy any **Minimum ON Timer** requirements and then restart the **Minimum OFF Timer** that must expire before the equipment is turned on in the new **MODE**. Going from any **HEAT** or **COOL** to **OFF** immediately shuts off any active equipment after the 10 second delay.

## SETTINGS

---

Use this screen to change or view the options in the thermostat. The advanced **SYSTEM SETTINGS** screens are only available from the thermostat. See *To configure advanced SYSTEM SETTINGS* (page 13).

Press a button or scroll the vertical yellow Row Indicator to see more buttons. When you press a button, the corresponding screen appears so you can view status and make adjustments.

## HUMIDITY

---

To adjust the thermostat's humidify and dehumidify setpoints:

- Drag the wheel up or down
- Tap the top of the wheel to decrease the setpoint by 1%
- Tap the bottom to increase the setpoint by 1%.

If cooling equipment is not available, **COOL TO DEHUMIDIFY** is not adjustable on the thermostat and the blue Dehum Setpoint wheel is not adjustable.

**HUMIDIFY** – not adjustable on the thermostat (the orange Hum Setpoint wheel is not adjustable) unless configured to use one of the following outputs:

- O/B
- Y3
- W2

**DEHUMIDIFY = YES** – When humidity is above the dehumidify target, the cooling setpoint is adjusted downward, increasing cooling demand, according to the equations in the following table, when you select **YES** for **DEHUMIDIFY** (not true for **OVERCOOL (2)** or **HUMIDIMIZER** selections).

Cooling Setpoint	Algorithm
$\leq 70^{\circ}\text{F}$	Use the cooling setpoint only
$70.1^{\circ} - 74.9^{\circ}\text{F}$	Cooling setpoint = Cooling Setpoint - (Cooling Setpoint - $70^{\circ}\text{F}$ ) x (Dehumidify Error / 10) with maximum dehumidify Error of 6% (i.e. use 6% if $>6\%$ )
$> 75^{\circ}$	Cooling setpoint = Cooling Setpoint - (Dehumidify Error / 2) with maximum dehumidify Error of 6%

When cooling to dehumidify, the minimum ON timer increases to 5 minutes and the second stage (or greater) is not started unless there is also a cooling demand.

**OVERCOOL 2°** commands the system to operate the compressor, within limits, when there is a dehumidification demand, even if there is no cooling demand. The system may overcool up to  $2^{\circ}\text{F}$  and no more, when satisfying a dehumidification demand.

## Humidi-MiZer™

When configured as a **HUMIDIMIZER** output, and the humidity level is above the dehumidify target, 24V is output at the selected terminal. When the humidity level is below the dehumidify target, 0 Vac is output on the selected terminal. There is a +1/-4% hysteresis around the dehumidify target to prevent rapid on/off cycling of the selected output.

This output may be connected to compressor outputs on commercial equipment. If the selected output is energized without any compressors being energized, the 5-minute time guard must be enforced.

Use the following table to determine values for the terminal outputs to the equipment, when specific demands are present.

### NOTES

- The value of X denotes that the setting may be **Off** or **On**, depending on the state of the **FAN ON WITH W** set on advanced **SYSTEM SETTINGS** screen.
- \* represents Y3, W2, or O/B, based on the item available and selected in **HUM/DEHUM OUTPUT** configuration. See *To configure advanced System Settings* (page 13).

	<b>Y1</b>	<b>Y2</b>	<b>W1</b>	<b>W2</b>	<b>G</b>	<b>*</b>
Fan	Off	Off	Off	Off	On	Off
Cool (1)	On	Off	Off	Off	On	Off
Cool (2)	On	On	Off	Off	On	Off
Dehumidify (HUMIDIMIZER)	Off	Off	Off	Off	On	On
Cool (1) and Dehumidify	On	Off	Off	Off	On	On
Cool (2) and Dehumidify	On	On	Off	Off	On	On
Heat (1)	Off	Off	On	Off	X	Off
Heat (2)	Off	Off	On	On	X	Off
Heat (1) and Humidify	Off	Off	On	Off	X	On
Heat (2) and Humidify	Off	Off	On	On	X	On



## FAN

---

Use this screen to adjust fan operation. The default setting for fan operation is **AUTO** for both **OCCUPIED** and **UNOCCUPIED** periods. When operating in **AUTO MODE**, the fan only runs when there is an active heating or cooling demand. When you select **ON**, the fan runs continuously, except during the **BLOWER ON DELAY** when a heat cycle is starting. There will be a 30-second minimum on/off timer when changing the **FAN MODE**.

These selections are not available if the thermostat has been configured for non-programmable operation.





**CAUTION** The **AUTO** selection is a violation of the ASHRAE 90.1 and California Title 24, but is a feature of the thermostat for building owners that mandate auto fan operation during occupied periods for energy conservation purposes.

## PROGRAM

---

You can only view the program schedule on this screen on the thermostat. You cannot adjust the schedule or setpoints. Permanent program schedule changes require the Connect App. Making temporary changes or pausing the program schedule are outlined in *Using the Connect App* (page 10).

The top center of the screen displays the program schedule day of the week. Swipe up or down to move from one day to the next on the program schedule. The vertical yellow Row Indicator moves up and down at the same time.

- The horizontal blue lines show the cool setpoints above, for each of the 4 programmable periods of the day (up to 3 occupied periods and 1 unoccupied period, if configured).
- The horizontal red lines show the heat setpoints below, for each of the 4 programmable periods of the day.
-  Occupied and  Unoccupied icons appear at the top of each period.
- The vertical dashed lines separate the program time changes throughout the day.
- The times at the bottom of the dashed lines show the schedule.
- The vertical yellow dashed line displays the current time of day.
- A short horizontal yellow dashed line depicts the current measured space temperature.
- Thermostat only: yellow vertical line shows current time of day
- The yellow lines show up only when viewing the current day of the week.

## HOLIDAY

---

This screen displays the current year's holiday schedule. On a holiday, the setpoints for the first **UNOCCUPIED** time range are used for the entire day. Scroll the vertical yellow Row Indicator to see more holidays.

## BANNER

---

Press the center of the scrolling Banner to switch to the screen indicated by the text. You can swipe the banner to change options, or, every 3 seconds a different screen name scrolls across the top that you can navigate to.

On the thermostat itself, you can select which screens you want on the Banner by pressing the buttons to check the ones you want and then uncheck the ones you do not want.

The default screens are:

- **DATE & TIME**
- **FAN STATUS**
- **OUTDOOR TEMP**
- **COOL SETPOINT**
- **HUMIDITY**
- **HEAT SETPOINT**

## DATE and TIME

---

On this screen, scroll or tap the Orange Hour wheel or Blue Minute wheel to adjust the date and time on the thermostat.

Switch to the **Date Adjust** screen and the **Time Adjust** screen using the green icon button at the right side of the screen. Scroll or tap the Orange Month wheel or Blue Day wheel.

Drag a wheel up or down or tap the top or bottom of the wheel to increase or decrease by 1 increment.

When the thermostat is first registered and connected to a Wi-Fi router, both the date and time are synced with the server (based on the location of the phone/tablet used to connect the thermostat to a router or based on the ISP location if a computer is used to connect the thermostat to a router). The time and date are synced at the top of each hour automatically, unless the **Sync Time To Server** option in the **SETTINGS > ADVANCED** screen is set to **NO**.

## SOFTWARE screen and BACKLIGHT screen

---

**SOFTWARE** — Displays the current software's status.

**BACKLIGHT** — Use to change the backlight intensity in Active and Dormant modes.

- The blue Active Backlight wheel adjusts the backlight intensity from 10% to 100%, (75% is the default and recommended) when the thermostat is in an active state (being accessed or viewed by the end user).
- The purple Dormant Backlight wheel adjusts backlight intensity from 0% to 25%, (25% is the default and recommended) when the thermostat is in a dormant state (not being viewed or adjusted by the end user).

Drag a wheel up or down or tap the top or bottom of the wheel to increase or decrease by 1 increment.

## ADVANCED

---

Use this screen to access and change more advanced settings.

Screen Name/Description	Default and Range
<b>SYNC TIME TO SERVER</b> — sync time and date with cloud server based on thermostat location, which is determined by your mobile app or ISP during setup	D: YES R: NO/YES
<b>SCREEN TIMEOUT</b> — the maximum amount of time the <b>BACKLIGHT</b> stays active when no activity is sensed at the thermostat	D: 15 SEC R: 5 to 30 SEC, in 5 second intervals
<b>PROXIMITY</b> — enable or disable proximity sensing that changes the screen backlighting from Dormant to Active when a person is sensed in front of the thermostat	D: YES R: NO/YES
<b>PROX SENSITIVITY</b> — change the proximity sensing feature from HIGH to MEDIUM to LOW. Increasing the sensitivity increases the range the sensor can detect presence, but also increases the possibility of a false presence	D: MEDIUM R: HIGH/MEDIUM/LOW
<b># PROGRAM DAY PARTS</b> — Number of periods per day for programming occupancy.	D: 2 R: 2 or 4
<b>DST</b> — enable or disable automatic Daylight Saving Time change in the thermostat	D: ENABLED R: DISABLED/ENABLED

Screen Name/Description	Default and Range
<p><b>WIRELESS</b> — enable or disable Wi-Fi for the thermostat. If disabled, then the Wi-Fi radio in this product is turned off and functions such as the following are not available:</p> <ul style="list-style-type: none"> <li>• Sync Time To Server</li> <li>• Outdoor Temperature via Wi-Fi Geo location</li> <li>• Server &amp; Wi-Fi Errors</li> <li>• Remote Access Services via App or Web</li> </ul> <p> <b>CAUTION</b> If you disable this function after the thermostat has been set up and connected to the local Wi-Fi network, you must set it up again using the mobile App.</p>	<p>D: ENABLED R: ENABLED/DISABLED</p>
<p><b>SOUND</b> — adjust the sound made when touching the thermostat</p>	<p>D: CLICK R: OFF, CLICK, or BEEP</p>

## FILTER

---

Available on the thermostat only.

Use to reset the **FILTER ALERT** and see the **FILTER RESET REMINDER** timer information. Press the **RESET** button to reset the timer to its configured value in the advanced **SYSTEM SETTINGS**. See *To configure advanced SYSTEM SETTINGS* (page 13).

## LOCKOUT

---

Locks out unauthorized changes made on the touchscreen. All touch interaction is locked out without the unlock code. After 5 failed attempts, a notification (fault) is sent to the registered owner of the thermostat through Wi-Fi. More unlock attempts are blocked for 15 minutes.

To set up a new PIN or change the current PIN, select the **ENABLE** button or the **CHANGE PIN** button, which displays on the **SET PIN** screen. If the thermostat does not already have a PIN, the **CHANGE PIN** button cannot be used.

On the **SET PIN** screen, use the 3 blue-digit **PIN** wheels to set the **PIN**. Set the 3-digit PIN and press the orange Save button to save the PIN and return to the Lockout Screen. Press the **DISABLE** button to cancel the **LOCKOUT** function and reset the **PIN** to **000**. The default is **000** and the range is **1** to **999**.

## CLEAN

---

Stops touchscreen interaction for 10 seconds to allow cleaning the screen with a dry nonabrasive cloth. A 10-second countdown shows on the **CLEAN** screen and then resumes normal operation.

## LOG

---

You can use this screen to view software update history, fault history, and system events. Swipe up or down on the vertical yellow Row Indicator to scroll through logged events.

The log includes:

- **STARTUP**
- **SOFTWARE UPDATE EVENTS**
- **POWER CYCLE EVENTS**
- **PARAMETER OUT-OF-RANGE EVENTS**
- **SERVER CONNECTIVITY EVENTS**
- **NON-VOLATILE MEMORY FAULTS**
- **TEMPERATURE FAULTS**

The list displays the 5 most recent logged events, with the most recent at the top. The last line in the list includes the **RESET LOG** command to clear the list. Pressing an event item displays a screen with more information. Press the **BACK** button to return to the **LOG** screen.

## STATUS

---

Displays the current status of

- thermostat outputs
- timers
- stages
- lockouts

Current timer status is displayed and can be cleared for testing and troubleshooting by pressing and holding the **TIMERS** text for 5 seconds. Press and hold **LOCKOUT TIMERS** for 5 seconds to clear timer values for COOL, E-HEAT, and HP HEAT.

Scroll the vertical yellow Row Indicator to see more options.

## **SERVICE**

---

Displays the dealer/installer service contact information. This information is editable using the mobile app, LAN mode transfer and Wi-Fi transfer.

## Installation test

Complete the following to field test the Carrier® Connect™ Wi-Fi Thermostat's outputs.

- 1 Press the **CHANGE** button to cycle the **MODE** screen through the following settings:
  - o **HEATING** (default) — not available in a cooling-only configuration
  - o **EM HEAT** — not available unless a heat pump is configured
  - o **COOLING** — not available in a heating-only configuration
  - o **FAN**
  
- 2 Press the **START** button.
  - a) The first stage of **HEATING, EM HEAT, COOLING, or FAN** starts running and the text reads **1ST STAGE: 180** or **FAN ON** and 180 seconds starts counting down.
  - b) The **START** button is replaced with a **STOP** button and the **CHANGE** button disappears.
  - c) Once the countdown reaches 0, if another stage exists, it starts and the text changes to **2ND STAGE: 180**.
  - d) If no other stage exists, the cycle ends, the text disappears, and the **Start** button reappears.
  - e) If a third stage exists, it starts running after the second stage countdown reaches 0.
  - f) While the **HEATING** and **EM HEAT MODES** are running, if a humidifier has been configured, a **HUM** button appears below the **STOP** button. If you press the **HUM** button, the text **HUMIDIFYING** appears and turns on the humidifier.
  - g) While the **COOLING MODE** is running, if a dehumidifier has been configured, a **DEHUM** button appears below the **STOP** button and, if pressed, the text **DEHUMIDIFYING** appears and the dehumidifier turns on.
  - h) Pressing the **STOP** button turns off running equipment, the **STOP** button is replaced with the **START** button, the **CHANGE** button reappears, and the second (stage running and countdown time) and third lines (humidifying or dehumidifying), are erased.
  - i) When you press the **CANCEL** button, any equipment that is running is turned off and the **SYSTEM SETTINGS** screen displays.
  - j) When you press the **HOME** icon, any equipment that is running is turned off and the **HOME** screen displays.

After 15 minutes of inactivity (no button presses), the installer test stops and the **HOME** screen displays.

## Troubleshooting

If the display does not turn on:

- 1 Check terminals R and C on the thermostat base.
- 2 Verify power is 24 Vac +/-10%.
- 3 Verify that the green LED on the base is flashing at 1 Hz.

**NOTE** If the green LED is not flashing and you do have 24 Vac on terminals R and C, you need to replace the thermostat.

## Outputs based on demand and configuration

Demands Stages	Y1	Y2	W1	W2	G	Y3	*Rev Val=0	*Rev Val=B
Fan Only	Off	Off	Off	Off	On	Off	X	X
Cool 1 (A/C)	On	Off	Off	Off	On	Off	X	X
Cool 2 (A/C)	On	On	Off	Off	On	Off	X	X
Cool 3 (A/C)	On	On	Off	Off	On	On	X	X
Cool 1 (Heat Pump)	On	Off	Off	Off	On	X	On	Off
Cool 2 (Heat Pump)	On	On	Off	Off	On	X	On	Off
Dehumidify	Off	Off	Off	Off	On	X	X	X
Cool 1 and Dehumidify	On	Off	Off	Off	On	X	X	X
Cool 2 and Dehumidify	On	On	Off	Off	On	X	X	X
Heat 1 (A/C)	Off	Off	On	Off	On	X	X	X
Heat 2 (A/C)	Off	Off	On	On	On	X	X	X
Heat 1 (Heat Pump)	On	Off	Off	Off	On	X	Off	On
Heat 2 (Heat Pump)	On	On	Off	Off	On	X	Off	On
Heat 3 (HP w/Emerg Ht)	On	On	On	On	On	X	Off	On
Heat 4 (HP w/Emerg Ht)	On	On	On	On	On	X	Off	On
Heat 1 and Dehumidify	Off	Off	On	Off	On	X	X	X
Heat 2 and Dehumidify	Off	Off	On	On	On	X	X	X
Heat Low (Electric)	Off	Off	On	Off	On	X	X	X
Heat Med (Electric)	Off	Off	Off	On	On	X	X	X
Heat High (Electric)	Off	Off	On	On	On	X	X	X

**NOTE** Use this table along with the HUM/DEHUM table, if either of those functions are enabled. See *HUMIDITY* (page 26).



## Fault definitions

The following Fault messages are displayed and logged in the banner during the fault condition and then sent to the Cloud server.

Faults	Condition
<b>ID TEMP SENSOR HIGH</b>	Temperature reading > 122 °F
<b>ID TEMP SENSOR LOW</b>	<ul style="list-style-type: none"> <li>• Temperature reading = 0</li> <li>• Reading not available</li> </ul>
<b>REMOTE SENSOR HIGH</b>	Remote temperature > 122 °F <b>NOTE</b> Displayed only if <b>REMOTE SENSOR</b> is set to <b>INDOOR</b> or <b>AVERAGE</b> .
<b>REMOTE SENSOR LOW</b>	Remote temperature = 0 <b>NOTE</b> Displayed only if <b>REMOTE SENSOR</b> is set to <b>INDOOR</b> or <b>AVERAGE</b> .
<b>HUM TEMP SENSOR HIGH</b>	Humidity sensor temperature > 122 °F <b>NOTE</b> Displayed only if using humidity temperature as a backup source during a fault condition with the primary temperature sensor.
<b>HUM TEMP SENSOR LOW</b>	Humidity sensor temperature = 0 <b>NOTE</b> Displayed only if using humidity temperature as a backup source during a fault condition with the primary temperature sensor.
<b>ID TEMP RANGE HIGH</b>	Indoor temperature is > 99.0 °F
<b>ID TEMP RANGE LOW</b>	Indoor temperature is < 40.0 °F
<b>HUM SENSOR FAILURE</b>	Any of the following: <ul style="list-style-type: none"> <li>• Humidity sensor timed out</li> <li>• Humidity reading is &gt; 99%</li> <li>• Humidity reading is 0</li> </ul>
<b>HUMIDITY RANGE HIGH</b>	Humidity reading is > 90%
<b>HUMIDITY RANGE LOW</b>	Humidity reading is < 10%
<b>OUTDOOR SENSOR FAILURE</b>	OD temp > 127 or < -60
<b>NOT CONNECTED TO SERVER</b>	Not connected to Ayla server
<b>NOT CONNECTED TO ROUTER</b>	Router signal strength is 0 = no bars = not connected
<b>WI-FI HARDWARE FAULT</b>	Communications error occurred with Wi-Fi module (resets after valid message received)
<b>ECONOMIZER FAULT</b>	Contact closure on remote sensor input, as determined by Economizer

## Recovering from a power outage

---

The Carrier® Connect™ Wi-Fi Thermostat stores the following critical information in a non-volatile flash memory:

- Installer settings
- Owner settings
- Program schedule
- Software information
- Dealer information
- Fault and system event information
- Date and time

The Carrier® Connect™ Wi-Fi Thermostat uses a capacitor to maintain date and time for approximately 2 hours, in order to maintain data during short power interruptions. If the power outage is longer than 2 hours, the date and time will automatically be updated once network connection is re-established.

## Resetting wi-fi access

---

To assign a new Wi-Fi access point or transfer the Carrier® Connect™ Wi-Fi Thermostat to a new account, follow these steps.

- 1 On the thermostat, not a mobile device, swipe the **HOME** screen twice to the left to navigate to the **MODE** screen and ensure the **MODE** is **OFF**.

**NOTE** The yellow line above a button indicates it is the current **MODE**.



- 2 Swipe to go to the **FAN** screen and then press and hold the **Fan Button**  for 5 seconds to get to the **SYSTEM SETTINGS** screen.

**NOTE** You can **ONLY** access the **SYSTEM SETTINGS** screens from the thermostat itself, not the app or web.

- 3 Enter the 3-digit security PIN code, if applicable, to open the **SYSTEM SETTINGS** screen.



- 4 Scroll down to **DISCONNECT WIFI**.



**CAUTION** Disconnecting the Wi-Fi requires setting up the Connect Thermostat using the Connect mobile application.

- 5 Select **YES**.
- 6 Use the mobile app on your phone or tablet to connect the thermostat to the desired Wi-Fi Access point. See the section of this guide titled *“Registering and setting up a mobile device for enhanced access (page 9)”*. Follow the instructions within the app.

## Document revision history

Important changes to this document are listed below. Minor changes such as typographical or formatting errors are not listed.

<b>Date</b>	<b>Topic</b>	<b>Change description</b>	<b>Code*</b>
8/28/19	Humidity	Removed note limiting output use	C-ST-CP-E

\* For internal use only





CARRIER CORPORATION ©2019

A member of the United Technologies Corporation family · Stock symbol UTX · Catalog No. 11-808-728-01 · 8/28/2019